

ST28

Track Loaders



**WACKER
NEUSON**
all it takes!



Radial Lift Track Loader

The ST28 offers the power and torque needed for any jobsite. This unit delivers 2,800 pounds of rated operating capacity at 50% and a lift height over 119 inches. The machine is equipped with a 74 hp turbo-charged Kohler Tier 4 Final engine offering class leading engine torque. Mechanical Hand-Foot and Selectable EH controls ensures operators with any control preference can efficiently operate the machine. With generous door width and height, visibility of the attachment and the surroundings is superior to the competition.

- With a top speed of nearly 10 MPH, travel time is reduced giving the operator more time throughout the day to get more tasks completed.
- Spacious extended cab maximizes room and comfort for the operator to move inside the cab.
- Quick and easy service access from the forward tilting cab and the arrangement of internal components makes it easy to maintain the machine.
- Class leading track-on-ground of 57.2" decreases ground pressure while increasing digging performance.
- Optional high flow hydraulics increase the range of usable attachments improving efficiency and

productivity.

ST28 Technical specifications

ST28

Operating data

Height top of ROPS	83 in
Overall length w/ bucket	136.6 in
Overall length w/o bucket	106.6 in
Height Hinge Pin Max	119.6 in
Operating weight	7,829 lb
Rated Operating Capacity ROC 50%	2,800 lb
Rated Operating Capacity ROC 35%	1,960 lb
Dump reach	27.8 in
Length of track on ground	57.2 in
Dump height max. at max height	91.3 in
Angle of departure	30.7 °
Tipping angle (bucket dump) w/ bucket at max height	42 °
Ground clearance	9.1 in
Breakout force max. - Bucket	5,300 lbf
Breakout force max. - Boom	5,000 lbf
Width	67.1 in
Width Track	12.6 in

Engine / Motor

Engine / Motor manufacturer	Kohler
Engine / Motor	KDI 2504 TCR
Engine performance	74 hp
Displacement	151.5 in ³
RPM / speed	2,750 rpm
Battery	950 CCA
Fuel tank capacity	30 US gal

Hydraulic system

Auxiliary Hydraulics- Standard Flow	20 US gpm
Auxiliary Hydraulics- High Flow	30 US gpm
Pressure aux. relief	3,500 psi
Hydraulic oil tank	2.9 US gal

Power transmission

Travel speed low	7 mph
Travel speed high	10 mph

ST28 Dimensions

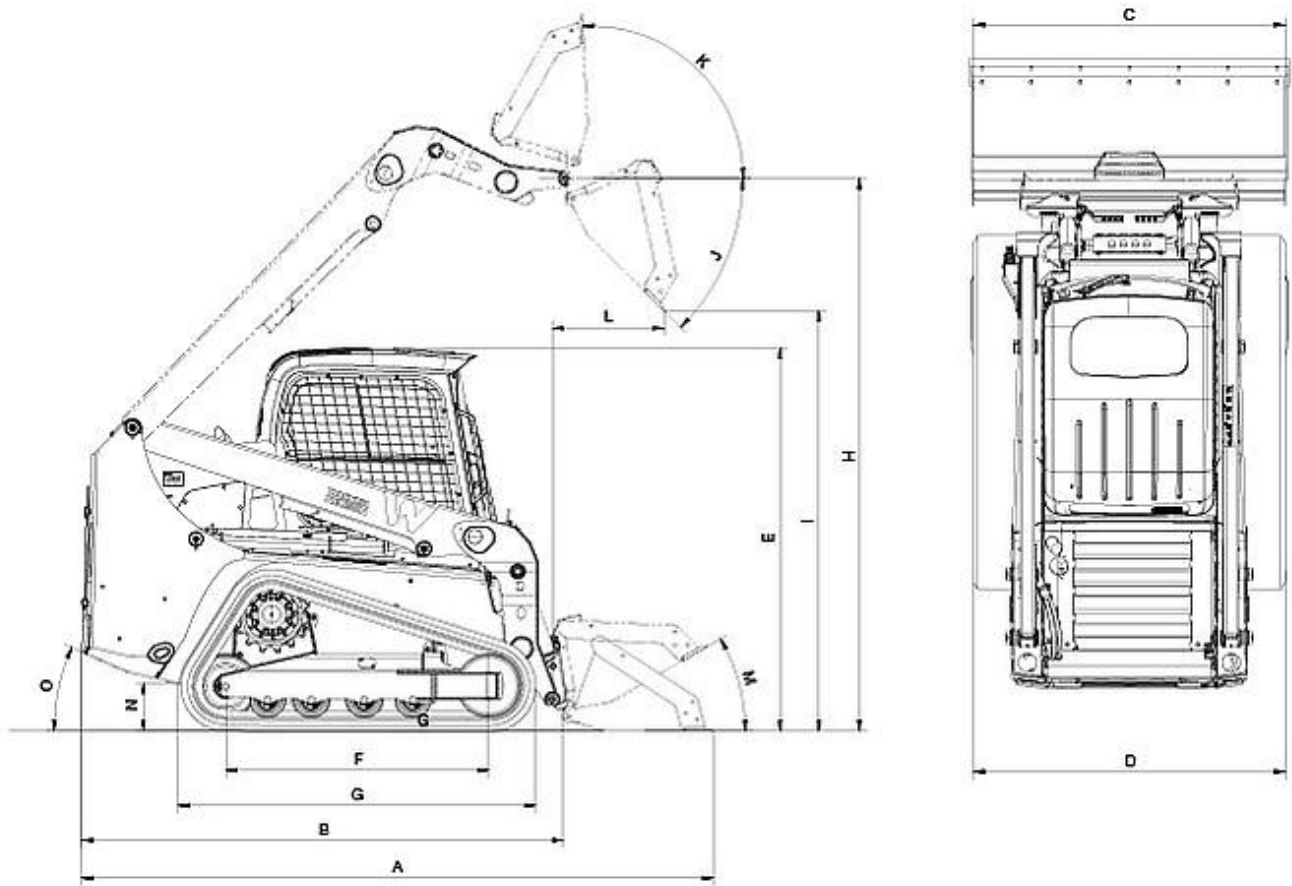

		ST28
A	Overall length with bucket	136.1 in
B	Overall length without bucket	106.6 in
D	Overall width without bucket	67.1 in
	Overall width without bucket (Wide Tracks)	70.3 in
E	Overall height	83 in
F	Wheelbase	57.2 in
H	Hinge pin height	119.6 in
I	Dump height max.	91.3 in
J	Dump angle	42 °
K	Bucket rollback at max. stroke height	30 °
L	Dump reach	29.3 in
M	Bucket rollback at ground level	30 °
N	Ground clearance	9.1 in
O	Angle of departure	30.7 °

Please note: that product availability can vary from country to country. It is possible that information / products may not be available in your country. More detailed information on engine power can be found in the operator's manual; the stated power may vary due to specific operating conditions. Subject to alterations and errors excepted. Applicable also to illustrations.
Copyright © 2019 Wacker Neuson SE.